

Power PCB Relay T9E

- 1 pole 30A, 1 formA(NO) or 1 formC(CO)
- High breaking capacity 7500 VA
- PCB and PCB/quick connect terminals
- UL class F insulation as standard
- Ambient temperature up to 105°C
- Plastic materials according to IEC60335-1

Typical applications
HVAC, power supplies, domestic appliances, measurement and control.

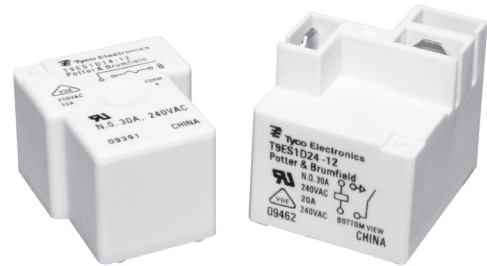

Approvals

VDE 40027903, UL E58304
Technical data of approved types on request.

Contact Data

Contact arrangement	1 form A (NO)	1 form C (CO)
Rated voltage	240VAC	
Max. switching voltage	250VAC (VDE); 300VAC (UL)	
Rated current	30A	20A/10A
Limiting continuous current	30A	
Breaking capacity max.	7500VA	5000/2500VA
Contact material	AgSnOlnO (AgCdO optional)	
Min. recommended contact load	1A, 5VDC or 12VAC	
Initial contact resistance	75 mΩ at 1A at 5VDC or 12VAC	
Frequency of operation, with/without load	6/120min ⁻¹	
Operate/release time max., including bounce	15/15ms	

Contact ratings

Type	Contact	Load	Cycles
------	---------	------	--------

IEC 61810

AgSnOlnO, 1W coil			
1	NO	30A, 250VAC, cosφ=1, 60°C	20x10 ³
1	NO	20A, 250VAC, cosφ=1, 85°C	100x10 ³
2	NO	20A, 250VAC, cosφ=1, 70°C	100x10 ³
1, 2	CO	20A / 10A, 250VAC, cosφ=1, 60°C	20x10 ³

AgSnOlnO, 900mW coil

1	NO	17A, 250VAC, cosφ=1, 105°C	100x10 ³
1	NO	20A, 250VAC, cosφ=1, 85°C	100x10 ³

EN 60730-1

AgSnOlnO, 1W coil			
1	NO	12(12)A, 240VAC, 60°C	100x10 ³

UL 508 1)

AgSnOlnO, 1W coil			
1, 2	NO	30A, 240VAC, general purpose, 25°C	100x10 ³
AgSnOlnO, 900mW coil			
1, 2	NO	TV-8, 125VAC, 25°C	25x10 ³

1) Additional UL 508 ratings are available.

Mechanical endurance	10x10 ⁶ ops.
----------------------	-------------------------

Coil Data

Coil voltage range	6 to 110VDC
Max. coil power	110% of nominal
Max. coil temperature	155°C
Coil insulation system according UL	Class F

Coil Data (continued)

Coil versions, DC coil

Coil code	Rated voltage VDC	Operate voltage VDC	Release voltage VDC	Coil resistance Ω±10%	Rated coil power W
Code D (1W) coil					
6	6	4.5	0.6	36	1
9	9	6.75	0.9	81	1
12	12	9	1.2	144	1
18	18	13.5	1.8	324	1
22	22	16.5	2.2	484	1
24	24	18	2.4	576	1
48	48	36.2	4.8	2304	1
110	110	82.5	11	12100	1
Code L (900mW) coil					
6	6	4.5	0.6	40	.9
12	12	9	1.2	155	.9
18	18	13.5	1.8	380	.9
24	24	18	2.4	660	.9

All figures are given for coil without preenergization, at ambient temperature +23°C.

Insulation Data

Initial dielectric strength		
between open contacts		1500V _{ms}
between contact and coil		2500V _{ms}
Initial surge withstand voltage		
between contact and coil		6kV (1.2μs/50μs impulse wave)
Initial insulation resistance		
between insulated elements		1x10 ⁹ Ω
Clearance/creepage		
between contact and coil		≥3mm/4mm

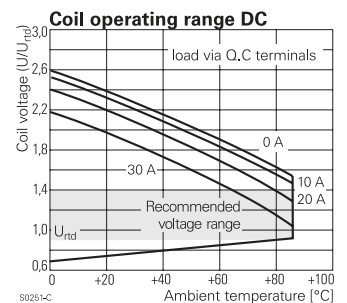
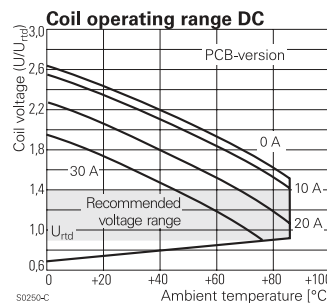

Coil operating ranges shown above are for 1W coils.

Power PCB Relay T9E (Continued)

Other Data

Material compliance: EU RoHS/ELV, China RoHS, REACH, Halogen content refer to the Product Compliance Support Center at www.te.com/customersupport/rohssupportcenter

Ambient temperature	-40°C to 85°C / 105°C
DC coil	
Category of environmental protection IEC 61810	RTII - flux proof (T9EV) RTIII - wash tight (T9ES)
Vibration resistance (functional)	1.5mm, 10-55 Hz
Shock resistance (functional)	10g for 11msec
Shock resistance (destructive)	100g

Other Data (Continued)

Terminal type connect	PCB-tht and PCB-tht + quick
Weight	26g mounting code 1 33g mounting codes 2 and 5
Resistance to soldering heat THT IEC 60068-2-20	260°C
Packaging/unit	tray/50 pcs., box/250 pcs.

Dimensions

PCB version

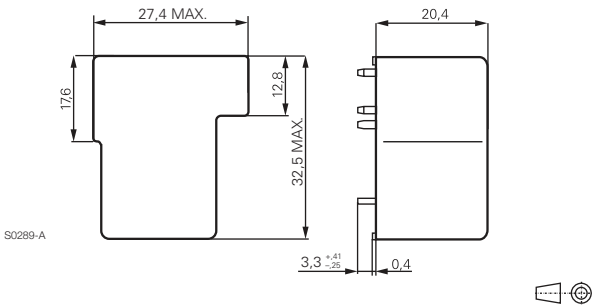

PCB/quick connect version

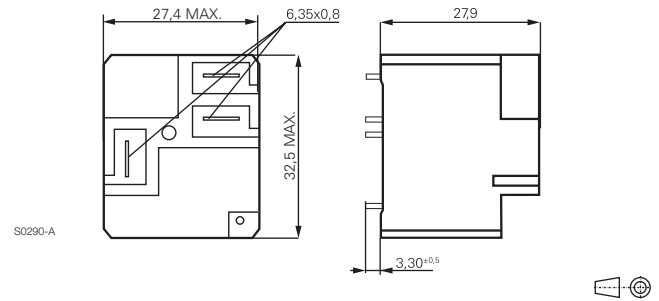

Terminal assignment

Bottom view on pins

1 form A

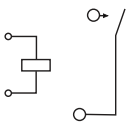

1 form C

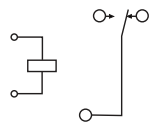

PCB layout

Bottom view on pins

PCB version

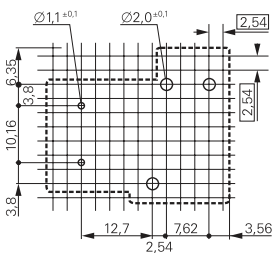

Only necessary terminals are present on single throw models. Consequently, some holes will be unnecessary for single throw models.

S0261-AA

PCB/quick connect version

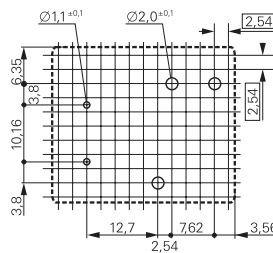

Only necessary terminals are present on single throw models. Consequently, some holes will be unnecessary for single throw models.

S0261-AH

